

BXP6555B

Brandt

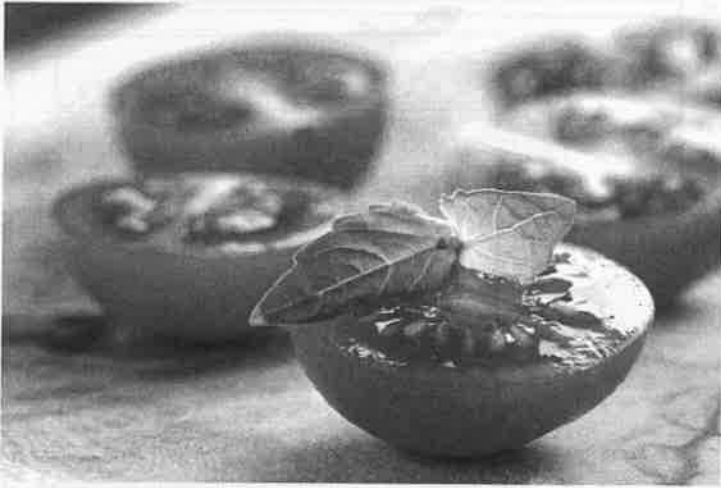

FR GUIDE D'UTILISATION
EN USER GUIDE

Four Oven



1

1.1

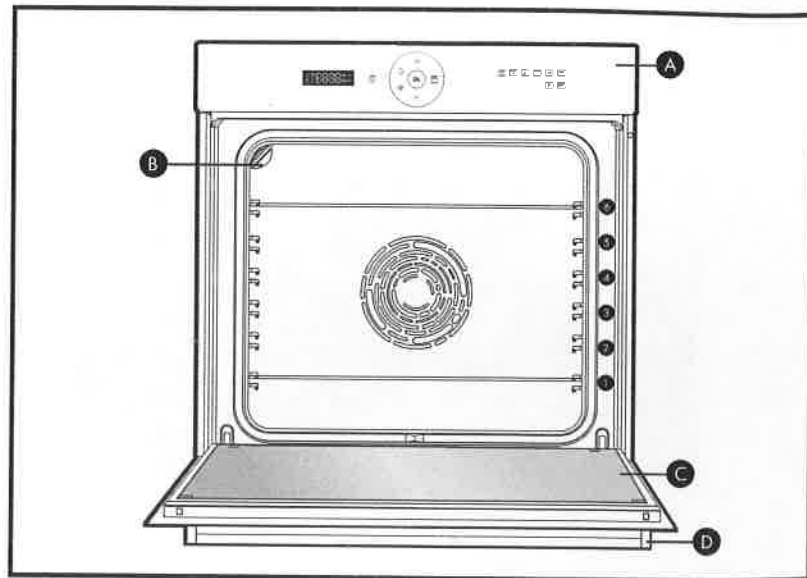

1.4

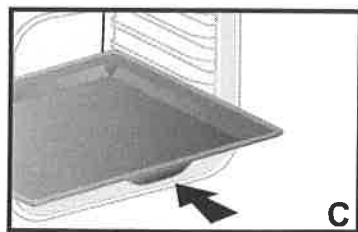
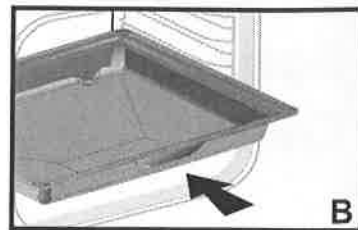
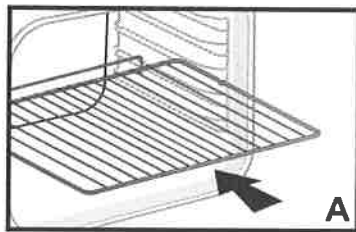

2

2.1

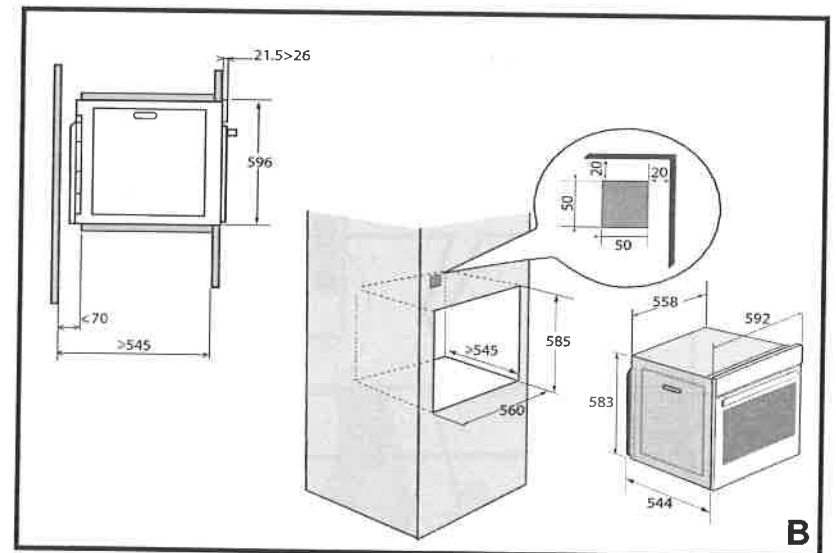
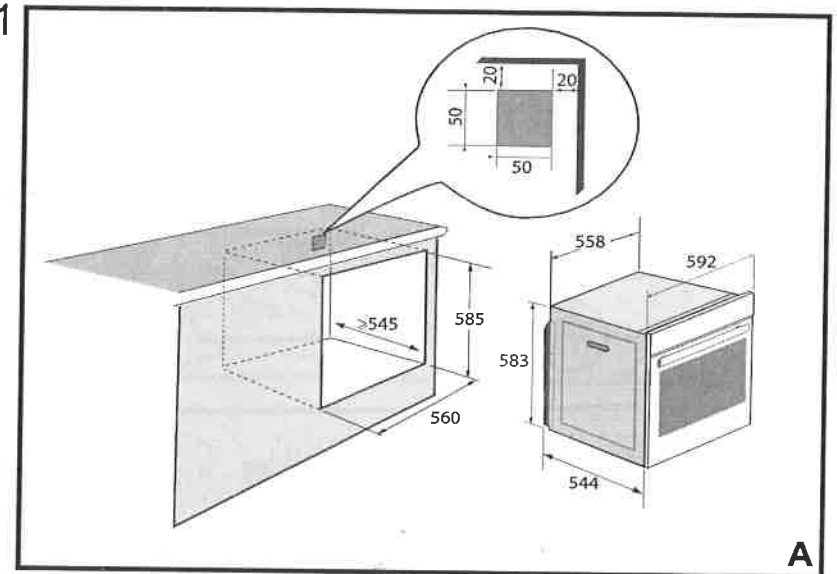

3

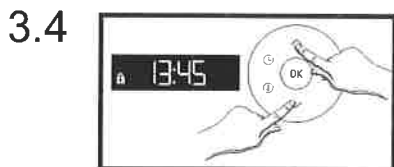
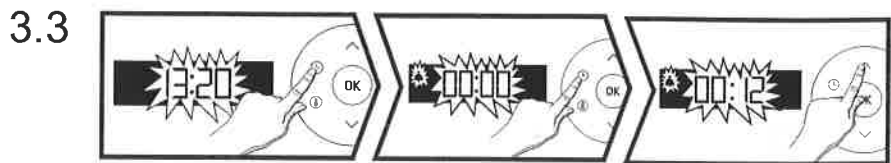
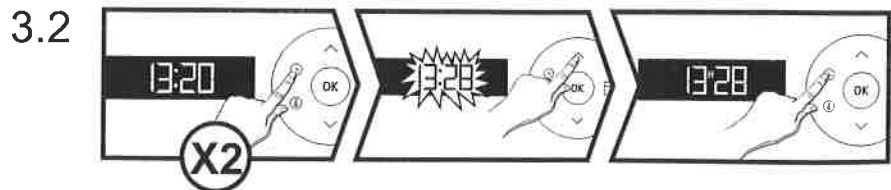
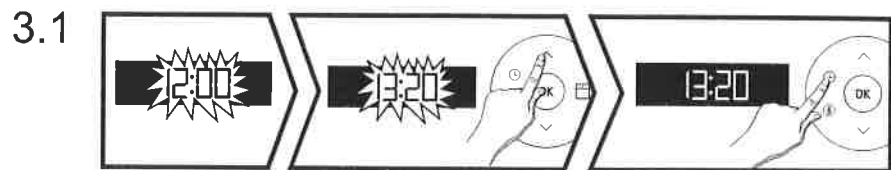

4

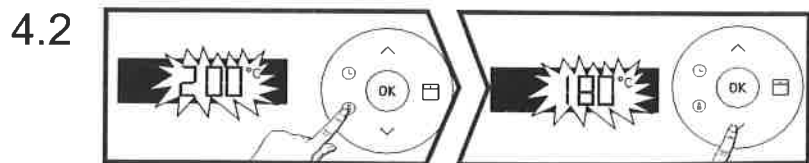

4

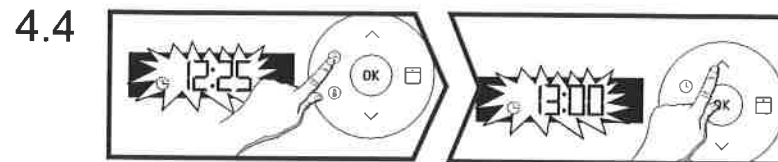
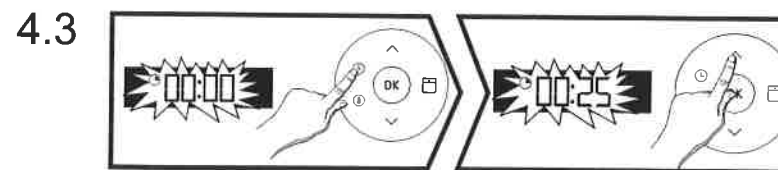

5

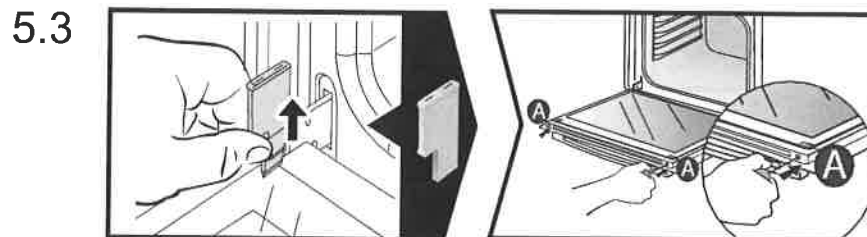
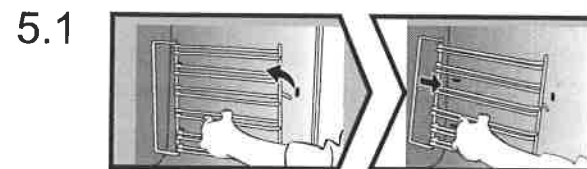

5



5.3

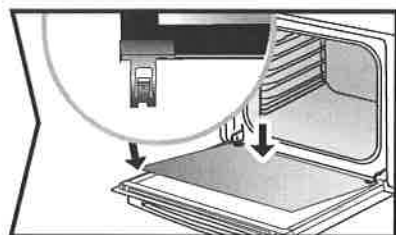
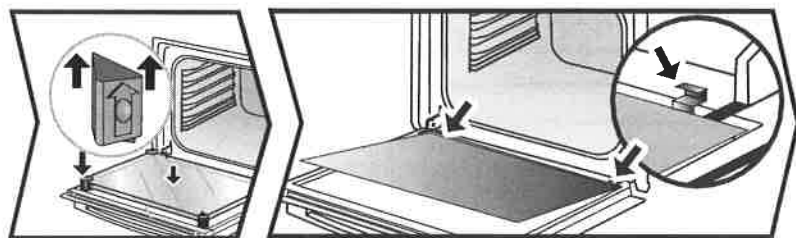
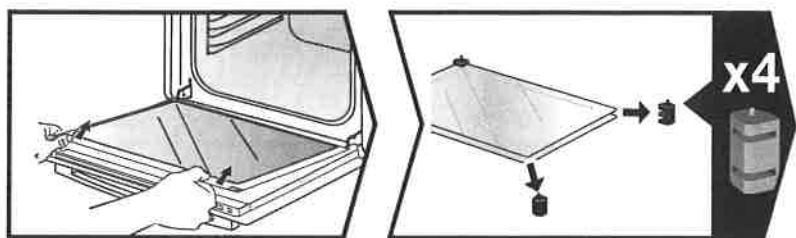

5.4

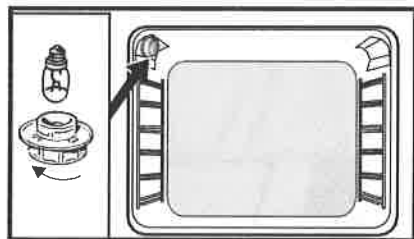

Chère Cliente, Cher Client,

Vous venez d'acquérir un produit **BRANDT** et nous vous remercions de la confiance que vous nous accordez.

Nous avons conçu et fabriqué ce produit en pensant à vous, à votre mode de vie, à vos besoins, pour qu'il réponde au mieux à vos attentes. Nous y avons mis notre savoir-faire, notre esprit d'innovation et toute la passion qui nous anime depuis plus de 60 ans.

Dans un souci permanent de toujours mieux satisfaire vos exigences, notre service consommateurs est à votre disposition et à votre écoute pour répondre à toutes vos questions ou suggestions.

Connectez-vous aussi sur notre site www.brandt.com où vous trouverez nos dernières innovations, ainsi que des informations utiles et complémentaires.

BRANDT est heureux de vous accompagner au quotidien et vous souhaite de profiter pleinement de votre achat.



Important : Avant de mettre votre appareil en marche, veuillez lire attentivement ce guide d'installation et d'utilisation afin de vous familiariser plus rapidement avec son fonctionnement

Dear Customer,

You have just acquired a **BRANDT** product and we would like to thank you.

We have designed and made this product with you, your lifestyle and your requirements in mind so that it meets your expectations. We have devoted our know-how, our innovative spirit and the passion that has been guiding us for over 60 years.

In an effort to ensure that our products meet your requirements in the best possible way, our Customer Relations department is at your disposal, to answer all your questions and to listen to all your suggestions.

Visit our website www.brandt.com where you will find our latest innovations, as well as useful and complementary information.

BRANDT is delighted to assist you every day and hopes you get the most out of your purchase.



Important: Before using your appliance, read this user guide carefully to familiarise yourself more quickly with its operation.

SAFETY INSTRUCTIONS

IMPORTANT SAFETY INSTRUCTIONS - READ CAREFULLY AND RETAIN FOR FUTURE USE.

This user guide is available for download on the brand's website.

Important:

When you receive the appliance, unpack it immediately. Give it an overall inspection. Make note of any concerns or reservations on the delivery slip and make sure to keep a copy of this form. Before starting your appliance, please read this installation guide carefully to familiarise yourself quickly with its operation. Keep this user guide with your appliance. If the appliance is ever sold or transferred to another person, ensure that the new owner receives this user guide.

Please become familiar with these recommendations before installing and using your oven. They were written for your safety and the safety of others.

— Before using your oven for the first time, heat it while empty for approximately 15 minutes. Make sure that the room is sufficiently ventilated.

— This oven was designed for use by private persons in their homes. This oven does not contain any asbestos-based components.

— Your appliance is intended for standard household use. Do not use it for commercial or industrial purposes or for any other purpose than that for which it was designed.

— Do not modify or attempt to

modify any of the characteristics of this appliance. This would be dangerous to your safety.

— Never place tin foil directly in contact with the oven floor as the build up of heat may damage the enamel.

— Do not place heavy weights on the open oven door, and make sure that children are able neither to climb nor sit on it.

— Do not use your oven as a larder or to store any items after use.

— After using your oven, make sure that all the controls are in their stop position.

— The oven must be turned off when cleaning inside the oven.

— Before removing the glass window, allow the appliance to cool down.

 This appliance may be used by children aged 8 years and older, and by persons with impaired physical sensorial or mental capacities, or without experience or knowledge, if they are supervised or have received prior instructions on how to use the appliance safely and have understood the risks involved. Children must not be allowed to play with the appliance. Cleaning and maintenance operations must not be carried out by children without

SAFETY INSTRUCTIONS

supervision.

— Children must be supervised to prevent them from playing with the appliance.

WARNING: The appliance and its accessible parts become hot during use. Be careful not to touch the heating elements inside the oven. Children under 8 years old must not be allowed near it unless they are supervised at all times.

— This appliance is designed to cook with the door closed.

— Before pyrolytic cleaning of your oven, remove all accessories and any thick deposits.

— During cleaning, the surfaces may become warmer than under normal conditions of use. It is advisable to keep children away from the appliance.

— Do not use a steam cleaner.

— Before removing the back wall, the appliance must be powered off. After cleaning, the back wall must be put back in place in accordance with the instructions.

— Do not use abrasive cleaning products or hard metal scrapers for cleaning the oven's glass door, as they could scratch the surface and cause the glass to shatter.

 **WARNING:** Make sure the appliance is disconnected from the power before replacing the lamp in order to avoid the risk of electric shock. Change

the lamp only when the appliance has cooled down. To unscrew the view port and the light, use a rubber glove, which will make disassembly easier.

 The electrical plug must remain accessible after installation.

It must be possible to disconnect the appliance from the power supply, either using a plug or by fitting a switch on the fixed wiring system in accordance with installation rules.

If the power cable is damaged, it should be replaced by the manufacturer, its after-sales service department or by a similarly qualified person in order to avoid danger.

— This appliance may be installed either under a worktop or in a cabinet column, as indicated on the installation diagram.

— Centre the oven in the unit so as to ensure a minimum distance of 10 mm between the appliance and the surrounding unit. The material of the unit supporting the appliance must be heat-resistant (or covered with a heat-resistant material). For greater stability, attach the oven to the unit with 2 screws through the holes provided on the side panels.

In order to avoid overheating, the appliance must not be installed behind a decorative door.

1 Description of the oven

1.1 PRESENTATION OF THE OVEN

- A** Control panel
- B** Light
- C** Door
- D** Handle

This oven has 6 positions for the accessories: shelf supports 1 to 6.

1.2 DISPLAY



- Cooking time
- End of cooking
- Keypad lock
- Timer
- Temperature indicator
- Pre-heating indicator
- Door lock

1.3 BUTTONS

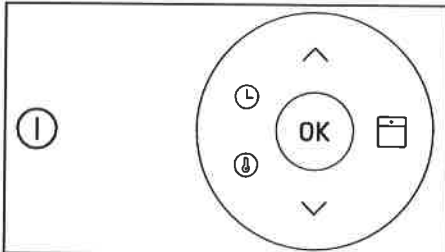

- On/Off
- Set cooking time
- Set temperature
- + button, menu navigation
- button, menu navigation
- Cooking functions
- OK Validation

1.4 ACCESSORIES (depending on model)

A • Anti-tip safety grid

The grid can be used to hold all dishes and moulds containing foodstuffs to be cooked or browned. It can be used for barbecues (to be placed directly on the grid).

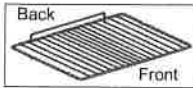

Insert the anti-tip safety grid towards the back of the oven.

B • Multi-purpose 45mm drip pan

When inserted in the supports under the grid with the handle towards the oven door, it collects juice and fat from grilling, and can be used half-filled with water as a double-boiler.

C • 20mm pastry dish

When inserted in the supports with the handle towards the oven door, it is ideal for baking cookies, shortbread and cupcakes. Its tilted surface makes it practical and easy to use. Can also be inserted into the supports under the grid to collect juice and fat from grilling.

⚠ Warning : Remove the accessories and supports from the oven before beginning pyrolysis cleaning.

💡 Tip To avoid fumes when cooking fatty meats, we recommend you add a small amount of water or oil to the bottom of the drip pan.

2 Installation

2.1 CHOICE OF LOCATION AND FITTING

The diagrams show the dimensions of a cabinet that will be able to hold your oven. This appliance may be installed either under a worktop (A) or in a column (B). If the cabinet is open, its opening at the back must be 70 mm maximum.

Install the oven in the furniture. To do this, remove the rubber stops and pre-drill a 2-mm diameter hole in the wall of the furniture to avoid splitting the wood. Attach the oven with the two screws. Reposition the rubber stops.

💡 Tip To be certain that you have properly installed your appliance, do not hesitate to call on a household appliance specialist.

ELECTRICAL CONNECTION

Your oven must be connected with a (standard) power cable with 3 conductors of 1.5mm² (1 live + 1 neutral + earth) which must be connected to a 220-240V_~ single-phase grid by means of a 1 live + 1 neutral + earth CEI 60083 standard power socket or via an all-poles cut-off device in compliance with the installation rules.

The safety wire (green-yellow) is connected to the appliance's ⊕ terminal and must be connected to the earth terminal of the electrical set-up.

The fuse in your set-up must be 16 amperes. We cannot be held responsible for any accident resulting from in-existent, defective or incorrect earthing.

⚠ Warning : If the electrical installation in your residence requires any changes in order to hook up your appliance, contact a professional electrician. If the oven malfunctions in any way, unplug the appliance or remove the fuse corresponding to the sector where the oven is hooked up.

3 Setting the clock

3.1 SETTING THE CLOCK

When switching on the display flashes at 12:00. Set the clock with or . Confirm by pressing **OK**.

3.2 CHANGING THE CLOCK

The oven must be off. Press twice on . The time of day flashes and you can now set it. Adjust the clock setting with or . Confirm by pressing **OK**.

3.3 TIMER

This function can only be used when the oven is off. Press . The timer flashes. Adjust the timer with and . Press **OK** to confirm. The timer

will then start. Once the time has lapsed, there is a sound signal. To stop it, press any key.

NB: You can modify or cancel the timer at any time. To cancel, go back to the timer menu and set to 00:00. Without having to confirm, the adjustment is automatically saved after a few seconds.

3.4 KEYPAD LOCKING

When the oven is off, press and at the same time until the symbol appears on the screen. Do the same to unlock.

4 Cooking

COOKING MODES (depending on model)

The following cooking modes: have a boost, which rapidly increases the temperature. To de-activate this mode, go to the settings chapter.

CIRCULATING HEAT*
Min temperature 35°C, max 250°C
Recommended for keeping white meat, fish and vegetables moist. For cooking multiple items on up to three levels.

TRADITIONAL PULSE*
Min temperature 35°C, max 275°C
Recommended for quiches, pies, tarts with juicy fruits, preferably in an earthenware dish.

PULSED BOTTOM
Min temperature 75°C, max 250°C
Recommended for moist dishes (quiches, tarts with juicy fruits, etc.). The pastry will be thoroughly cooked on the bottom. Recommended for recipes which rise (cake, brioche, kügelhopf, etc.) and for soufflés which will not be stopped by a crust on the top.

TRADITIONAL **ECO***
Min temperature 35°C, max 275°C
Recommended for slow and delicate cooking: tender game. To seal red meat roasts. For simmering in a covered casserole, dishes that were begun on the hob (coq au vin, stew).

**FULL GRILL**

Min temperature 180°C, max 275°C

**MEDIUM GRILL**

Min temperature 180°C, max 275°C

Pre-heat the oven for five minutes.

Slide the drip tray into the bottom shelf to collect the grease.

**GRILL PULSE**

Min temperature 100°C, max 250°C

Roasts and poultry are juicy and crisp all over.

Slide the drip tray on to the bottom shelf support.

Recommended for all spit-roasted poultry or meat, for sealing and thoroughly cooking a leg or a rib of beef. To retain the moist texture of fish steaks.

**KEEP WARM / RISING BREAD DOUGH**

Min temperature 35°C, max 100°C

Recommended for letting dough rise for bread, brioche, kügelhopf, etc. without exceeding 40°C (plate warming, defrosting).

**PIZZA**

Min temperature 35°C, max 275°C

Pre-heat and then put in the oven on the 3rd shelf support.

**BOOST**

Min temperature 35°C, max 275°C

To rapidly pre-heat the oven.

* Sequence(s) used to obtain the results indicated on the energy label in compliance with European standard EN 50304 and in accordance with European Directive 2002/40/EC:

Advice on how to save energy

In mode, the light inside the oven automatically turns itself off after 90 seconds. Keep the oven door closed during cooking.

4.1 IMMEDIATE COOKING

Press . The cooking function is displayed. To change it, press .

Your oven recommends a temperature, which can be altered. Adjust the temperature with and . Confirm by pressing .

Press **OK**. Cooking starts immediately.

The temperature indicator flashes until the temperature has been reached.

4.2 CHANGING THE TEMPERATURE

Press .

Adjust the temperature with and . Confirm by pressing **OK**.

The oven starts to heat; the cooking function flashes. A series of beeps sounds when the oven has reached the selected temperature.

MEMO ACTIVE FUNCTION.

Your oven has the "MEMO ACTIVE" function. This is how it works:

If the same cooking function was used for the last three cooking sessions, the function will be memorised and automatically suggested to you the next time.

- For each cooking function, if you modify the recommended temperature three times with the same instructions, it will be saved as a new recommended temperature.

You can de-activate this function in the settings menu (see paragraph 7.1)

4.3 PROGRAMMING THE COOKING TIME

Use the immediate cooking programme, then press ; the cooking time flashes.

The display flashes at 0:00 to indicate that a setting may be entered. Press and to adjust the cooking time.

Confirm by pressing **OK**.

SMART ASSIST FUNCTION.

Your oven has the "SMART ASSIST" function, which suggests a modifiable cooking time at the time of programming, depending on the cooking mode selected.

See the table below.

COOKING FUNCTION (depending on model)	COOKING TIME RECOMMENDATION
TRADITIONAL	30 min
TRADITIONAL PULSE	30 min
CIRCULATING HEAT	30 min
PULSED BOTTOM	30 min
ECO	30 min
MEDIUM GRILL	10 min
FULL GRILL	7 min
GRILL PULSE	15 min
PIZZA	15 min
BOOST	5 min

4.4 DELAYED START

Proceed in the same way as for a programmed time. After setting the cooking time, press ; the cooking end time flashes.

The display flashes. Set the cooking end time with and .

The cooking end time is automatically saved after a few seconds (or confirm by pressing the button twice). The cooking end time display stops flashing.

5



Cleaning

CLEANING THE OUTER SURFACES

Use a window washing product applied to a soft cloth. Do not use abrasive creams or scouring sponges.

PPYROLYSIS CLEANING

Before starting pyrolysis cleaning, remove any large overspills, if any. Remove the excess grease on the door using a damp sponge.

As a safety measure, cleaning only occurs after the

door locks automatically; it is impossible to unlock the door.



Remove the accessories and supports from the oven before beginning pyrolysis cleaning.

5.1 REMOVING THE SHELF SUPPORTS

Lift the front part of the wire shelf support upwards. Press the entire shelf support and release the front hook from its housing. Then gently pull the whole of the support towards you to release the rear hooks from their housing. Pull out the two shelf supports.

5.2 IMMEDIATE PYROLYSIS

> Pyro 2 hours, non modifiable (oven cooling time not included)

> **PyroExpress** in 59 minutes. (oven cooling time not included)

The **PyroExpress** function benefits from the heat accumulated during the previous cooking session to rapidly clean a slightly soiled oven using the principles of pyrolysis, in under one hour, depending on certain conditions.



PyroExpress is only possible if your oven is still sufficiently hot, just after cooking. If this is not the case, a 90-minute classic pyrolysis cycle will automatically begin.

To activate pyrolysis, select the pyrolysis function of your choice. Confirm by pressing **OK**. The symbol displays as well as the length of time for which the oven will be unavailable.

The door is locked during pyrolysis; the symbol will appear on the display. At the end of the cleaning cycle, 0:00 will appear on the display and the door will be unlocked.

DELAYED PYROLYSIS

Follow the instructions described in the «immediate pyrolysis» paragraph and refer to Chapter 4.4 delayed start to adjust the pyrolysis end time.

After these steps have been completed, the start of pyrolysis is delayed so that it finishes at the programmed time.

5.3 CLEANING THE INSIDE GLASS

To make it easier to clean the inside glass, remove the glass panels. Before doing this, remove any excess grease with a soft cloth and washing up liquid.

Warning

Do not use abrasive cleaning products or hard metal scrapers for cleaning the oven's glass door, which could scuff the surface and cause the glass to shatter.

REMOVAL

Open the door fully and block it with the plastic wedge provided in your appliance's plastic pouch. Remove the first clipped glass panel:

Use a tool (screwdriver) to press the slots **A** in order to unclip the glass panel.

Remove the glass panel.

Depending on the model, the door consists of two additional glass panels, with a black rubber spacer at each corner. If necessary, remove them to clean. Do not soak the glass panels in water. Rinse with clean water and dry off with a lint-free cloth.

RE-ASSEMBLING THE DOOR

After cleaning, reposition the four rubber stops with the arrow upwards and reposition all of the glass panels.

Slip the last glass panel into the metal stops, then clip it in with the shiny side facing outwards. Remove the plastic wedge. Your appliance is now ready for use again.

5.4 REPLACING THE OVEN LAMP.

Warning:

Make sure the appliance is disconnected from the power before replacing the lamp in order to avoid the risk of electric shock. Change the lamp only when the appliance has cooled down.

Bulb specification: 15 W, 220-240 V~, 300°C, E14 cap.

To unscrew the view port and the light, use a

6 Settings

6.1 MENU

You can adjust different settings on your oven. To do so:

Press until you get to the "MENU" display then press again to select the different settings.

Activate or de-activate the different parameters with and ; see table below.

To exit "MENU" mode, press until you get to the clock display.

	AUTO: In cooking mode, the light inside the oven automatically turns itself off after 90 seconds. ON: In cooking mode, the light is on all the time.
	Activate/de-activate the beeping sound of the buttons
	Activate/de-activate demonstration setting
	Activate/de-activate memo active mode
	Activate/de-activate booster mode

7 ? Anomalies and solutions

You may resolve certain little problems yourself:

The oven is not heating. Check that the oven is correctly connected and that your installation's fuse is not out of service. Increase the selected temperature.

The oven light is not working. Replace the bulb or the fuse. Check that the oven is correctly connected.

The cooling fan continues to operate after the oven stops. This is normal; the fan may continue running until a maximum of 1 hour after cooking to lower the temperature inside and outside the oven. If the fan runs for over an hour, contact the After Sales Department.

The pyrolysis cleaning cycle does not begin. Check that the door is locked. If there is a door locking or temperature sensor fault, contact the Customer Services Department.

The symbol flashes in the display. Door locking fault; contact the Customer Services Department.

8 Environment

CARE FOR THE ENVIRONMENT

The packaging materials of this appliance can be recycled. Help to recycle them and protect the environment by placing them in the municipal containers provided for this purpose.

Your appliance also contains many recyclable materials. It therefore is marked with this symbol to indicate that old appliances must not be mixed with other waste.

The recycling of the appliances organised by the manufacturer will this be optimised, in compliance with the European directive 2002/96/CE on used electronic and electrical equipment.

Contact your town hall or retailer for the used appliance collection points closest to your home.

Thank you for helping to protect the environment.

9 Service Calls

SERVICE CALLS

Any repairs made to your appliance must be carried out by a qualified professional authorised to work on the brand. When calling, please provide the complete references of your appliance (commercial reference, service reference, serial number), so that we can handle your call better. This information appears on the manufacturer's nameplate attached to your equipment.

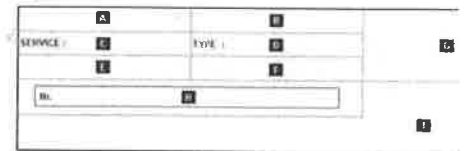
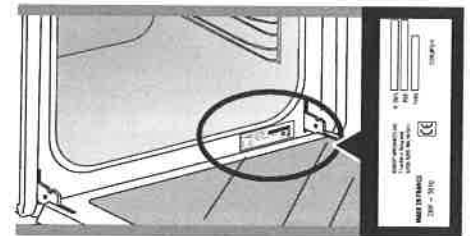

B: Commercial reference
C: Service reference
H: Serial number

GENUINE REPLACEMENT PARTS

During maintenance work, request that only *certified genuine replacement parts* are used.



DISHIES	[Icon]		[Icon]		[Icon]		[Icon]		[Icon]		[Icon]		[Icon]		min
	LEVEL		LEVEL		LEVEL		LEVEL		LEVEL		LEVEL		LEVEL		
Meat															
Roast pork (1kg)	200	2					180	2							60
Roast veal (1kg)	200	2					180	2							60-70
Roast beef	240	2													30-40
Lamb (leg, shoulder, 2.5kg)	220	1			220				200	2					60
Poultry (1kg)	200	2			220		180	2			210	3			60
Large pieces of poultry	180	1													60-90
Chicken thighs					220	3					210	3			20-30
Pork/veal chops					210	3									20-30
Beef ribs (1kg)					210	3					210	3			20-30
Lamb chops					210	3									20-30
Fish															
Grilled fish					275	4									15-20
Cooked fish (bream)	200	3					180	3							30-35
Fish in papillote	220	3					200	3							15-20
Vegetables															
Gratins (cooked foods)					275	2									30
Potato gratin	200	2					180	2							45
Lasagne	200	3					180	3							45
Stuffed tomatoes	170	3					160	2							30
Pastries															
Sponge cake			180	2							180	2			35
Swiss roll	220	3									180	2			5-10
Buns	180	1	210								180	2			35-45
Brownies	180	2					175	3							20-25
Cake - Pound cake	180	1	180	1							180	2			45-50
Clafoutis	200	2					180	3							30-35
Baked custards	165	2									150	2			30-40
Cookies - Shortbread	175	3													15-20
Kugelhopf			180	2							180	2			40-45
Meringues	100	2									100	3			60-70
Madeleines	220	3					200	3							5-10

*Depending on the model

DISHIES	[Icon]		[Icon]		[Icon]		[Icon]		[Icon]		[Icon]		[Icon]		min
	LEVEL		LEVEL		LEVEL		LEVEL		LEVEL		LEVEL		LEVEL		
Pastries															
Madeleines	220	3					200	3							5-10
Choux pastry	200	3					180	3					180	3	30-40
Flaky pastry hors d'oeuvres	220	3					200	3							5-10
Savarin cake	180	3											175	3	30-35
Shortcrust tart	200	1					195	1							30-40
Thin flaky crust tart	215	1					200	1							20-25
Tart made with yeast-based	210	1					200	1							10-30
Other															
Skewers	220	3			210	4									10-15
Terrine pâté	200	2					190	2							80-100
Shortcrust pizza	200	2													30-40
Dough-based pizza															15-18
Quiches															35-40
Soufflé													180	2	50
Pies	200	2													40-45
Bread	220						200		220						30-40
Bread	180				275	4-5									2-3
Casseroles (stews)	180	2											180	2	90-180

*Depending on the model



All T°C and cooking times are given for pre-heated ovens.

N.B: Before being placed in the oven, all meat must remain at least 1 hour at room temperature.

RELATIONSHIP OF SETTINGS TO TEMPERATURE									
Setting	1	2	3	4	5	6	7	8	9 maxi
° Fahrenheit	85	140	195	250	300	355	410	465	525
° Celsius	30	60	90	120	150	180	210	240	275

Recipe with yeast (depending on model)

Ingredients:

- Flour 2 kg • Water 1240 ml • Salt 40 g • 4 packets of dehydrated baker's yeast

Mix the dough in a mixer and allow to rise in the oven.

Method: For yeast-based pastry recipes. Pour the dough into a heat-resistant dish. Remove the wire shelf supports and put the dish on the bottom.

Pre-heat the oven to 40–50°C with the circulating heat function for five minutes. Stop the oven and allow the dough to rise for 25-30 minutes thanks to the residual heat.

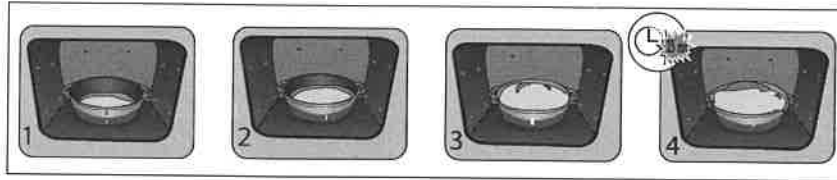

PERFORMANCE TESTING ACCORDING TO STANDARD CEI 60350

FOOD	☐			⊗			☉			PREHEAT	ACCESSORIES
	°C	SHELF	TIME	°C	SHELF	TIME	°C	SHELF	TIME		
Shortbread (8.4.1)	175	3	24min							NO	Deep Tray
Small cakes (8.4.2)	185	2	22min	160	3-1	42min				NO	Deep Tray
Fatless sponge cake (8.5.1)	180	1	30min	180	3-1	40min				NO	Mould on grill
Apple pie (8.5.2)	185	2	35min 40min	180	2	50min 55min				NO	Grill
Surface browning (9.2.2)							275	3	2-3min	Pre-heat for 5min	Cook 2-3 min on grill